

Article number: 6160402517

Description: Welding hub for taper bush type MSB
for taper bush 2517

Measures

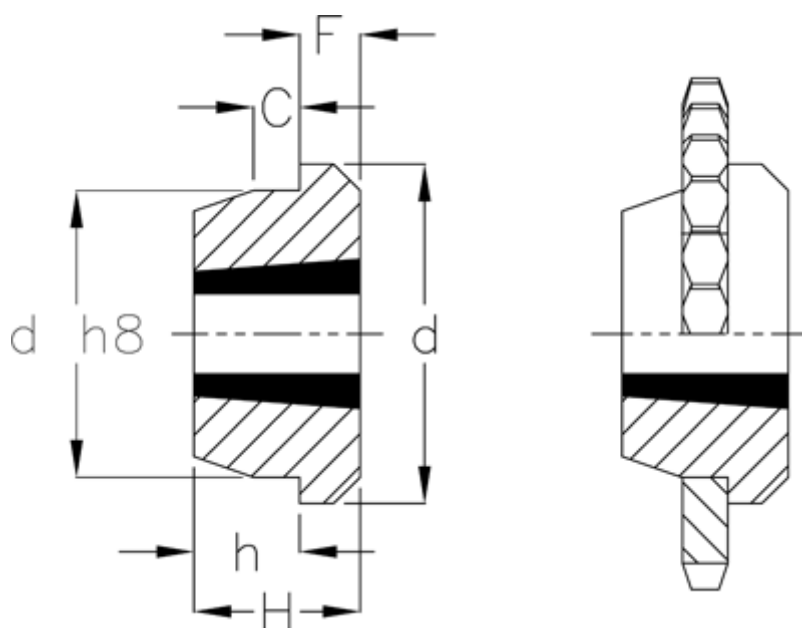

C	= 13
d	= 127
d H8	= 110
F	= 19
For taper bush	= 2517
H	= 45
h	= 26